

ASSESSMENT REGARDING THE FLUID EQUATION

$$W = PV \text{ (WORK = PRESSURE x VOLUME)}$$

AS IT RELATES

TO THE WORKING CAPABILITY OF PRESSURISED FLUIDS

APPLIED IN

THE CONVENTIONAL PISTON ACTUATOR

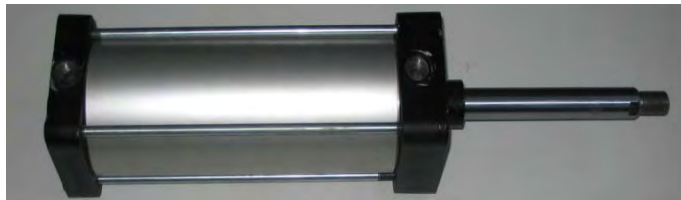

AND

THE DIAMOND-SHAPED ACTUATOR

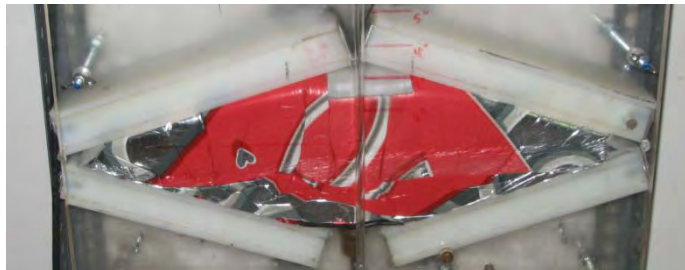

PREPARED BY:

David Strain
analystsofpneumatic@bellnet.ca
<http://www.apscontrols.ca>
(905) 640-2333 (1-800-646-8414)

EXECUTIVE SUMMARY

The fluid equation $WORK = PRESSURE \times VOLUME$ ($W = PV$) applies to the linear fluid performance regarding conventional piston actuators.

In these cases work input = work output ($WI = WO$).

The fluid equation $WORK = PRESSURE \times VOLUME$ ($W = PV$) does **not** apply to the non-linear fluid performance regarding diamond-shaped actuators.

In the initial stages of the diamond-shaped actuators' stroke, work input is less than work output ($WI < WO$).

Many engineer/scientists have tested the physical model concluding this fact.

Diamond-shaped actuators are more efficient than conventional piston actuators in the early stages of the diamond-shaped actuators' stroke.

PATENTED APPLICATION CONCEPT

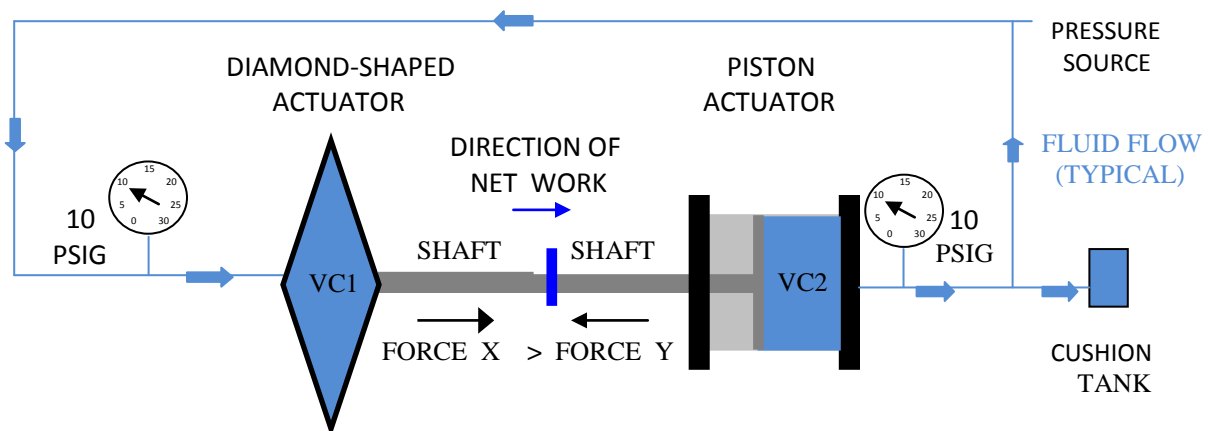

The diamond-shaped actuator expends 85% of its work potential generating its own source of fluid, pumping fluid from the piston actuator.

The remaining 15% of the diamond-shaped actuator's work potential may be extracted, addressing work requirements other than producing its own fluid source.

15% net work achieved = ((force "X" - force "Y") x travel)

$VC1$ (volume change one) < $VC2$ (volume change two)

REPORT'S PURPOSE

Present information illustrating:

- 1- The equation $W = PV$ applies to the linear fluid performance in conventional piston actuators, but does **not** apply to fluid performance in diamond-shaped actuators.
 - 2- The diamond-shaped actuator performance is non-linear as it progresses through its stroke regarding the work/pressure/volume relationship.
 - 3- Diamond-shaped actuators are more efficient than conventional piston actuators in the early stages of the diamond-shaped actuators' stroke.
-

CONTENTS

- Page one -- Graph illustrating linear power characteristics regarding conventional piston actuators.
- Page two -- Graph illustrating non-linear power characteristics regarding diamond-shaped actuators.
- Page three -- Graph illustrating the efficiency difference between conventional piston actuators and diamond-shaped actuators.
- Page four -- Summary

**DIAMOND-SHAPED ACTUATOR EQUILIBRIUM POINTS
AT VARIOUS PRESSURES WITH A CONSTANT 59.75# LOAD**

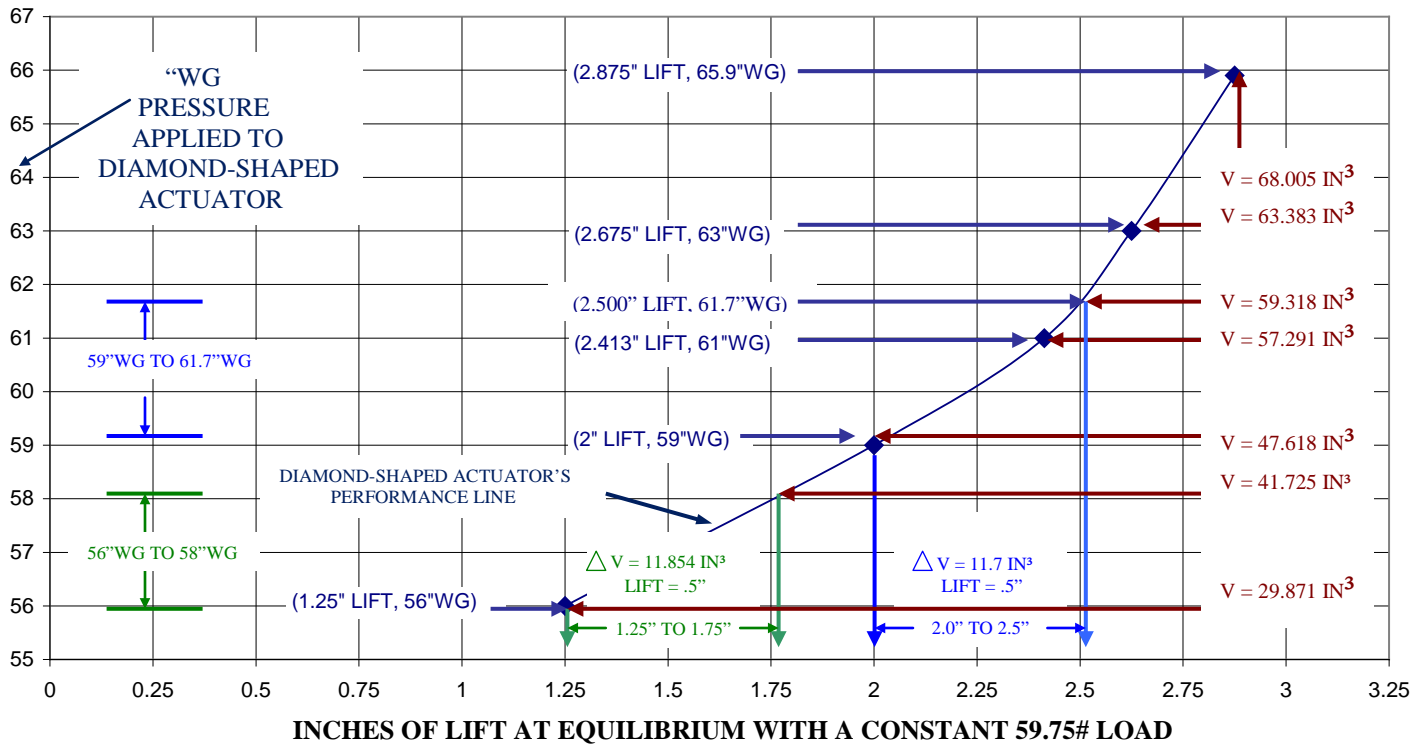

The above graph illustrates the equilibrium performance of our test model with a constant 59.75 pound load.

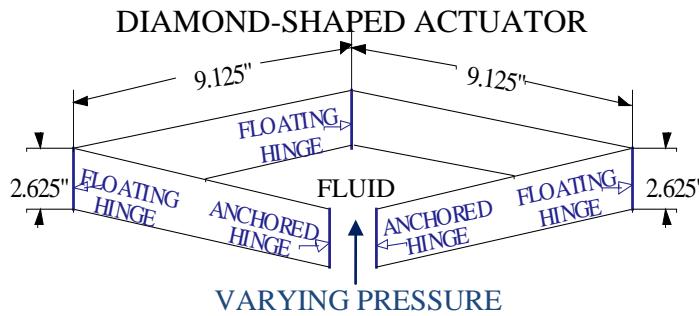

The table below presents data regarding two segments of travel: each being one half inch.

SEGMENT	TRAVEL	VOLUME CHANGE	LOAD	FLUID PRESSURE		
				LOW	HIGH	AVERAGE
1.25"-1.75"	.5"	11.854 IN ³	59.75 lb	56" WG	58.0" WG	57.00" WG
2.00"-2.50"	.5"	11.700 IN ³	59.75 lb	59" WG	61.7" WG	60.35" WG

The output is equal regarding both segments of travel, each lifting 59.75 lb through .5".
 $(W=FD) \quad W = 59.75 \text{ lb} \times .5 \text{ in} = 29.87 \text{ in/lb}$

The input work for one segment from 1.25" to 1.75" is:
 $(W=PV) \quad 57" \text{ WG} (2.057 \text{ PSI}) \times 11.854 \text{ IN}^3 = 24.38 \text{ in/lb}$

The work input for the segment from 2.0" to 2.5" is:
 $(W=PV) \quad 60.35" \text{ WG} (2.178 \text{ PSI}) \times 11.7 \text{ IN}^3 = 25.48 \text{ in/lb}$

NOTE: The work output for both segments is equal (29.87 in/lb), maintaining equilibrium, but the work inputs are different (24.38 in/lb and 25.48 in/lb).

EQUILIBRIUM COMPARISON REGARDING THE DIAMOND-SHAPED ACTUATOR AND THE CONVENTIONAL PISTON ACTUATOR

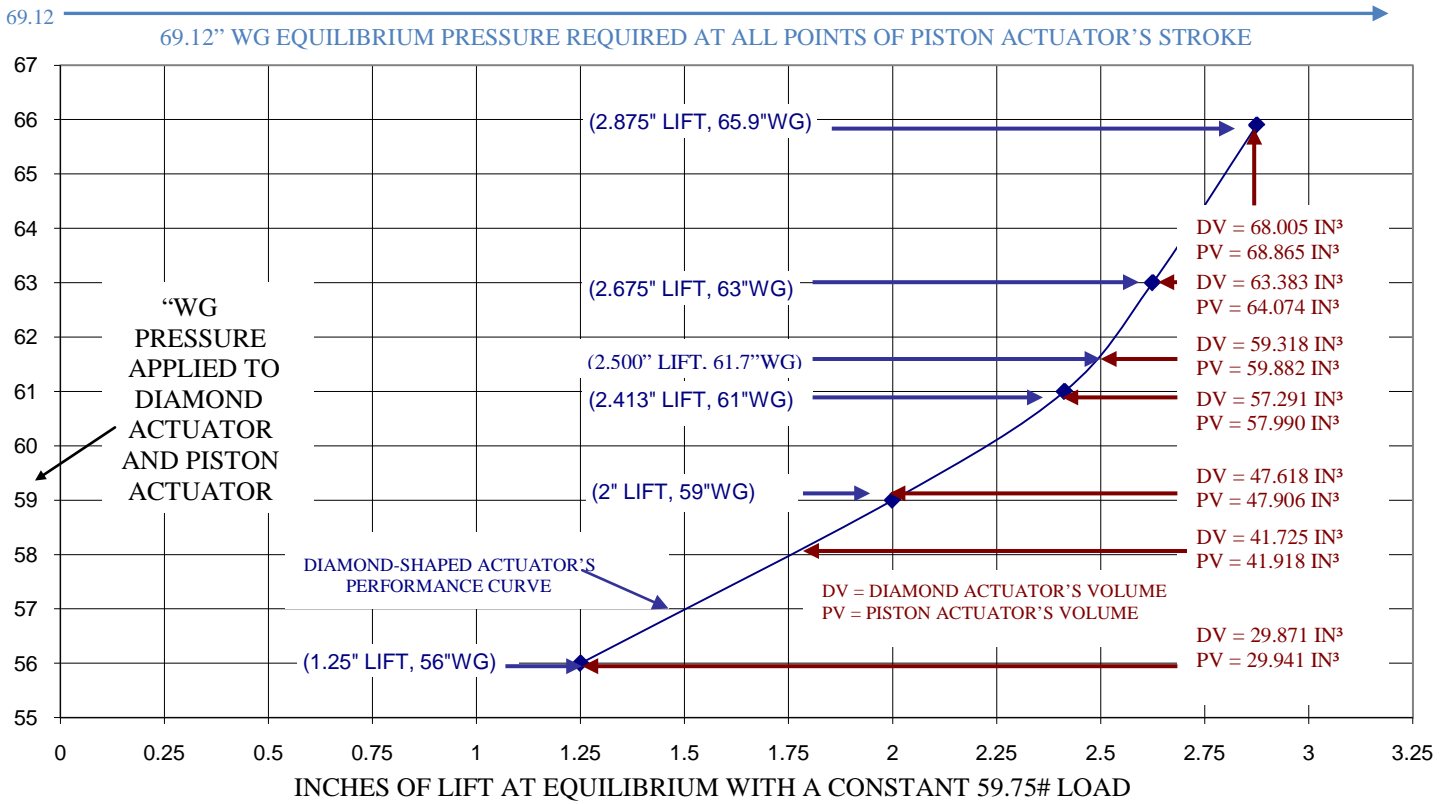

CONVENTIONAL PISTON ACTUATOR
CONSTANT 59.75 LB FORCE

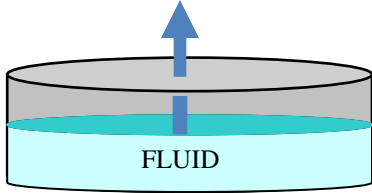

CONSTANT PRESSURE OF 69.12" WG (2.494 PSI)

DIAMOND-SHAPED ACTUATOR

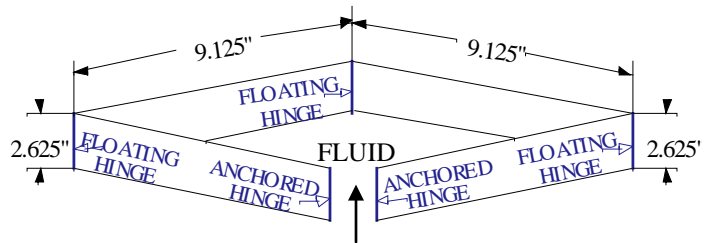

VARYING PRESSURE

The table below presents the efficiency comparison regarding equilibrium with an equal load of 59.75 pounds on both the piston actuator and the diamond-shaped actuator.

TRAVEL	PISTON ACTUATOR EQUILIBRIUM PRESSURE	DIAMOND EQUILIBRIUM PRESSURE	DIAMOND'S ADVANTAGE
1.250"	69.12" WG (2.4944 PSI)	56.0" WG	18.98%
1.750"	"	58.0" WG	16.08%
2.000"	"	59.0" WG	14.64%
2.413"	"	61.0" WG	11.75%
2.500"	"	61.7" WG	10.73%
2.675"	"	63.0" WG	8.85%
2.875"	"	65.9" WG	4.66%

NOTE:

The piston actuator requires the same pressure of 69.12" WG (2.494 PSI) at all points in its travel, maintaining the equilibrium force of 59.75 pounds to match the 59.75 pound load.

The diamond actuator requires varying pressures during its illustrated travel maintaining an equilibrium force of 59.75 pounds matching the 59.75 pound load.

SUMMARY

- 1- The equation $W = PV$ defines fluid performance regarding conventional piston actuators. The work input for every .5" of the example conventional piston actuator's travel requires 29.87in/lb of work. The input work matches the output work of 29.87 in/lb. The relationship is linear.
- 2- The equation $W = PV$ does not define fluid performance regarding diamond-shaped actuators. The two example .5" travel segments of our model produced identical work output of 29.87 in/lb, but their work input was different, being 24.38 in/lb and 25.48 in/lb. Both the volume and pressure were different for each travel segment. In this case $W = W$; however, PV for the first segment of travel \neq PV for the second segment of travel.

<u>WORK SUMMARY OF EXAMPLE ACTUATORS</u>				
<u>ACTUATOR STYLE</u>	<u>TRAVEL RANGE</u>	<u>WORK RELATIONSHIP</u>		
CONVENTIONAL PISTON	ANY .5" OF DRIVE	WORK IN (29.87 in/lb)	=	WORK OUT (29.87 in/lb)
		≠		
DIAMOND-SHAPED	.5" (1.25" TO 1.75")	WORK IN (24.38 in/lb)	≠	WORK OUT (29.87 in/lb)
		≠		
DIAMOND-SHAPED	.5" (2.00" TO 2.5")	WORK IN (25.48 in/lb)	≠	WORK OUT (29.87 in/lb)

- 3- The diamond-shaped actuator achieves more work relative to a conventional piston actuator with identical fluid input, regarding both pressure and volume. This occurs only during the first portion of the diamond-shaped actuator's travel.
- 4- The diamond-shaped actuator is more efficient than the conventional piston actuator, at varying magnitudes, depending on the angle variation of the diamond-shaped actuator's walls.
- 5- This is the main corner stone regarding the patented invention "DIAMOND-SHAPED FLUID POWERED LINKAGE, SYSTEM AND ENGINE".
The efficiency differential produces a work differential, allowing the diamond-shaped actuator to attain its complete source of fluid via pumping the fluid from the conventional piston actuator. The diamond-shaped actuator expends approximately 85% of its work potential generating the total fluid requirement of that action. The diamond-shaped actuator experiences a surplus work potential of approximately 15% after generating its own total fluid requirement relating to each stroke.